

# Best Science in Scale-Up and Tech Transfer

## Thermodynamics (Mass & Heat Balances)

Lab scale

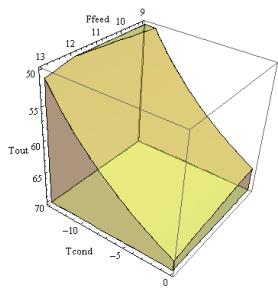

Manufacturing scale

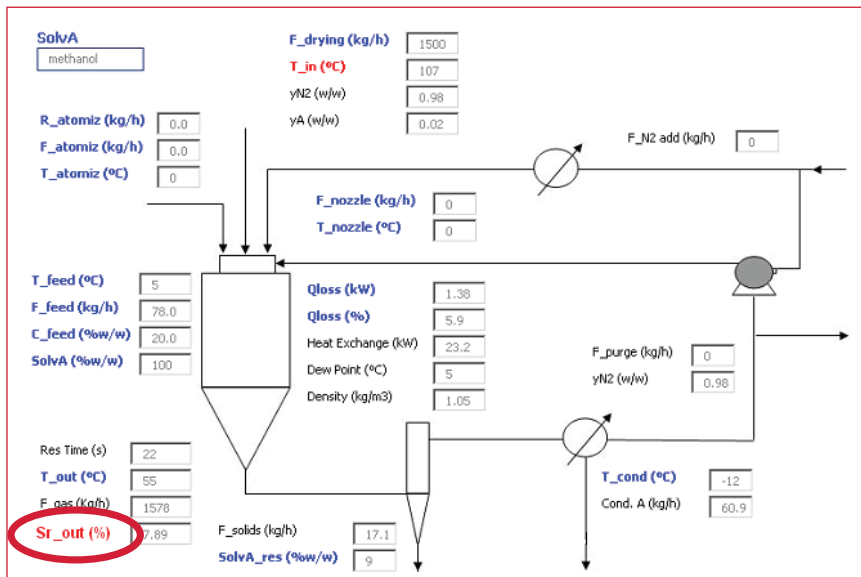
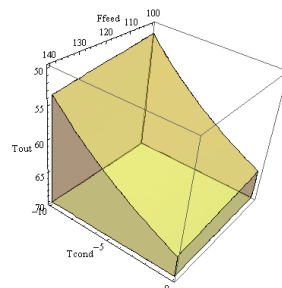

## Atomization (Particle Formation)

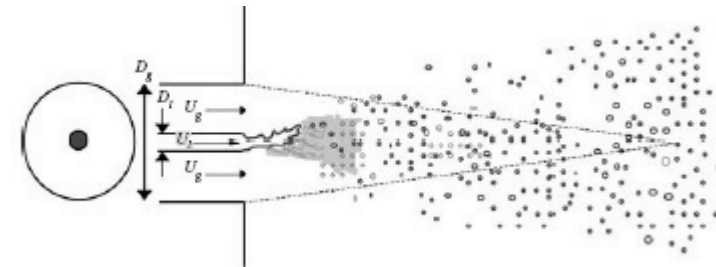

(C.M. Varga et al., 2003)

## Kelvin - Helmholtz instability

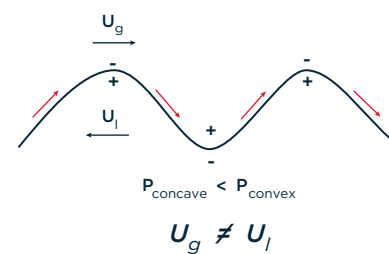

(Senecal, 1999)

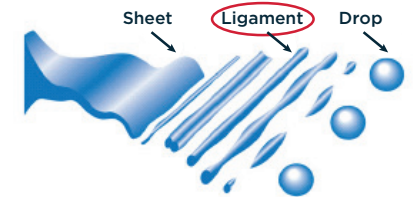

(Spray Drying Systems Co., 2006)

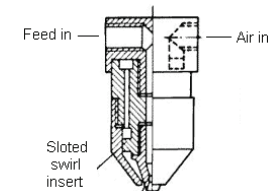
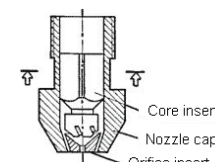

(adapted from NIRO)